

INSTRUCTION MANUAL

----- duo-battery charging solar controller,

For RVs, Caravans, and boats

-----EPIP20-DB series

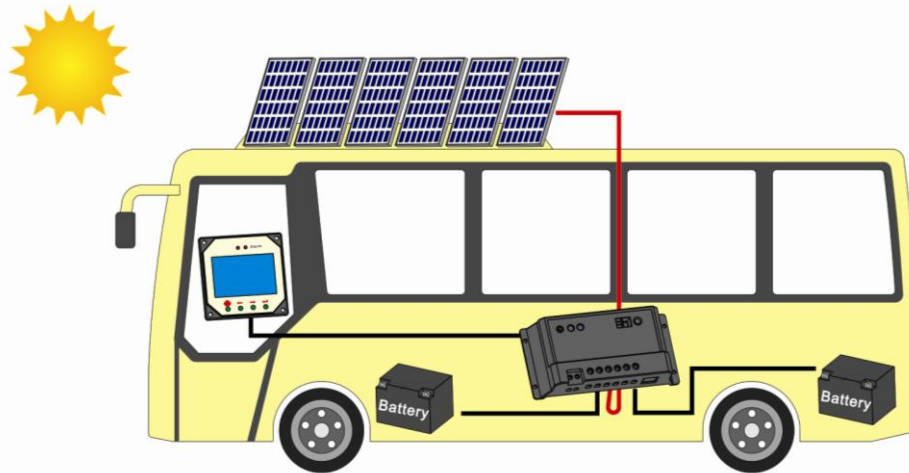

RATINGS (12V or 12/24V auto work)

EPIP20-2B, 12V or 12/24V auto-work, 10Amp

EPIP20-2B 12V or 12/24V auto-work, 20Amp

NOTES: For use with solar panels only

TECHNICAL INFORMATION

Setpoint	Sealed battery	Flooded battery	Gel battery
Regulation voltage	14.2V	14.4V	14.6V
Boost voltage	14.4V	14.6V	14.8V
Float voltage	13.7V	13.7V	13.7V
Maximum solar voltage	30V(or 55V)		
Battery voltage range	1-15V		
Boost time	30 minutes		
Self-consumption	4mA at night, 10mA at charging		
Meterbus connection	8-pin RJ-45		
Temp. compensation	-30mV/12V		
Terminals	4mm ²		
Temperature	-35°C to +55°C		

Note: all the data is for 12V, for 24V, please use 2x.

Major feature of duo-battery controller:

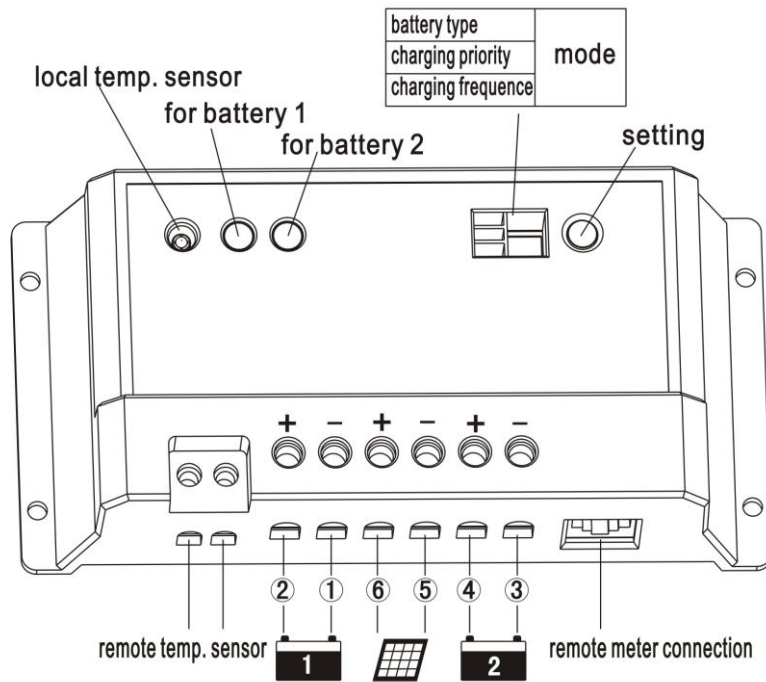

(Note: connect the components as the 1-6)



Connect with the battery #1



Connect with the battery #2



Connect with the PV.

Remote temp. sensor

A connection point for RTS(option) to remotely monitor battery temperature.

Local temp. sensor

Measures ambient temperature. Battery regulation is adjusted accordingly.

For battery 1

Provides charging & battery status and errors

For battery 2

Provides charging & battery status and errors

Remote meter connection

A communication port for the remote meter.

Note: where is no RTS, the controller calculate the data which got from the local temp. sensor. The controller will come to RTS automatically when the RTS was connected.

SETTING MODE:

battery type	mode
charging priority	
charging frequency	

I

Three leds flashing, each LED express different specifications, choose the LED first according to the following information, and then press the switch for 5 seconds until the number flashing, choose one number as you need, and leave it and the number you set will be saved.

- 1st led is the battery type setting,

Number shows	Battery type
1	Sealed battery
2	Gel battery
3	Flooded battery

- 2nd led is for charging priority, only set the percentage you want for battery #1, the controller will automatically calculate the rest for battery #2.

Number shows	Battery #1 charging	Battery # 2 charging
0	0%	100%
1	10%	90%
2	20%	80%
3	30%	70%
4	40%	60%
5	50%	50%
6	60%	40%
7	70%	30%
8	80%	20%
9	90%(pre-set)	10%

Note: in the normal charging status, the controller will divide the charging as the setting. While battery #1 is fully charged, more charge current will be diverted to battery #2, and return to the setting charging automatically when the battery #1 is in low voltage.

When the controller detects there is only battery #1, all the charging will go to the battery #1 automatically.

- 3rd led is for charging frequency.

Number shows	PWM Charging frequency
0	25Hz(pre-set)
1	50Hz
2	100Hz

TROUBLESHOOTING:

1. LED blinking, short circuit, check the PV and battery, and make sure that they are in correct connection.
2. LED slowly flashing, fully charged.
3. LED ON, on charging
4. LED frequent flashing, no charging, and there is battery
5. LED OFF, no battery or over voltage.

MECHANICAL DRAWING:

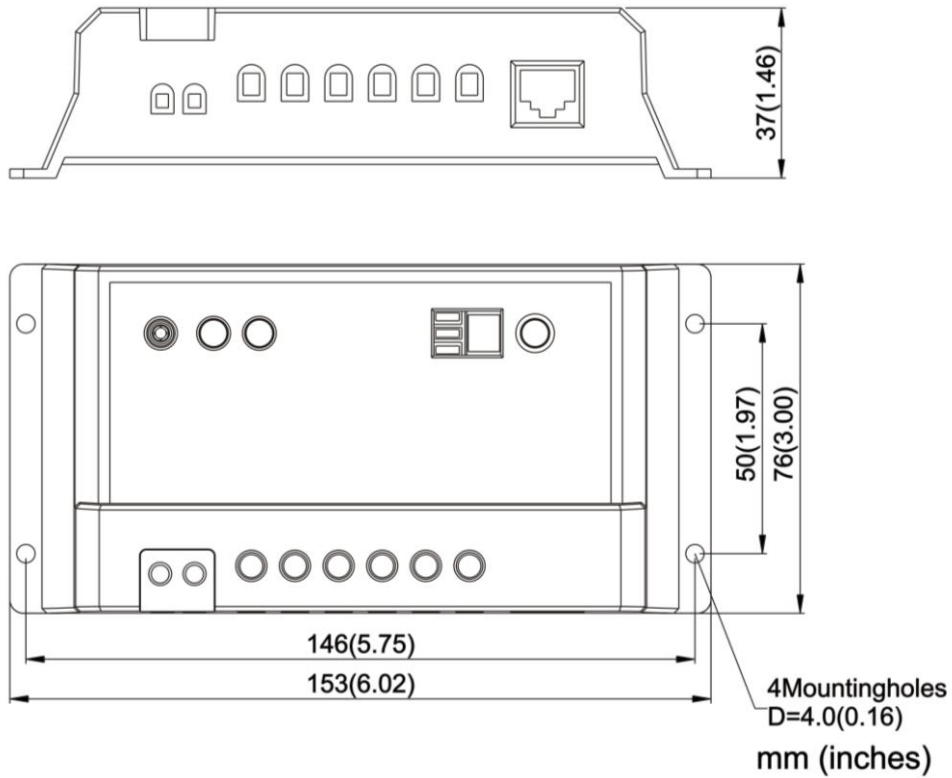

REMOTE METER DISPLAY:

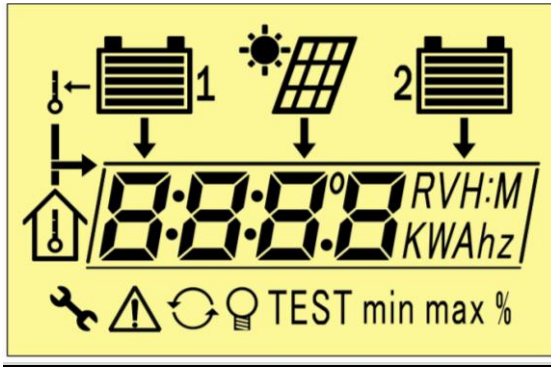

REMOTE METER OPERATION INSTRUCTION:

the key(from left to right) is: K1-K4, or Next \downarrow , Left \leftarrow , Right \rightarrow , Set \circ .

The meter display as following order:

Solar panel, battery 1, battery 2, other data as four team data. Use K2 or K3 to check the data between the teams. Symbol \curvearrowright is the repeat between the team 1 and team 4. K1 is the key for repeating the data. Data shows as picture 2.

Data setting instructions: press K4 for setting, K1 for next data and save it. K4 for next data, but no save. K2 and K3 for modify the data, shows as picture 3.

Backlight instruction: press any key while its connected, the backlight will be on. And set the backlight timer on setting mode. Backlight options:

OFF: backlight is off all the time

On: backlight is on all the time in any case.

B: 30 backlight on for 30 seconds

B: 20 backlight on for 20 seconds

B: 10 backlight on for 10 seconds

B: 05 backlight on for 5 seconds

Note: backlight timer calculated as the last key press. And backlight has 2 class:

FULL: high bright

HALF: low bright

Data repeat: auto or manual, options as following:

Auto each team data will repeat every 3 seconds, K1 for next team. K2, K3 for data repeating in the team.

OFF data will not repeat automatically, unless press K2 or K3, or K1 for the next team data.

System checking: at any time, press K3+K4, it will check and display the related data automatically. Details as PICTURE 4. If there is NO, means there is no connection. If the connections is correct, the related data will be displayed. If no remote temperature sensor is connected, the meter will show thermometer and NO. if connection is correct, it will show the data it detects. **OPEn** means no battery connection or over voltage, the data will be displayed while the connection is right.

Data erase to 0: at any time, press K1+K2, the data will be erased to 0, such as max, min, Ah. AH accumulate from 0.

PICTURE 2.

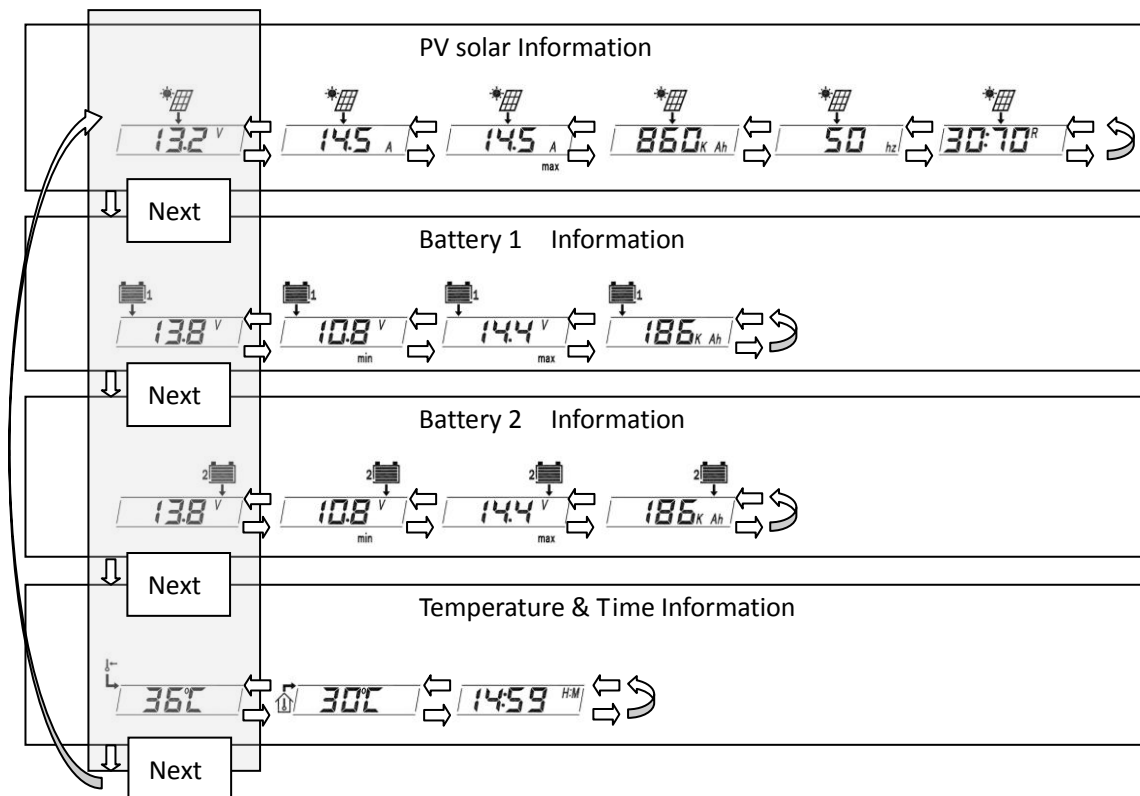

PICTURE 3

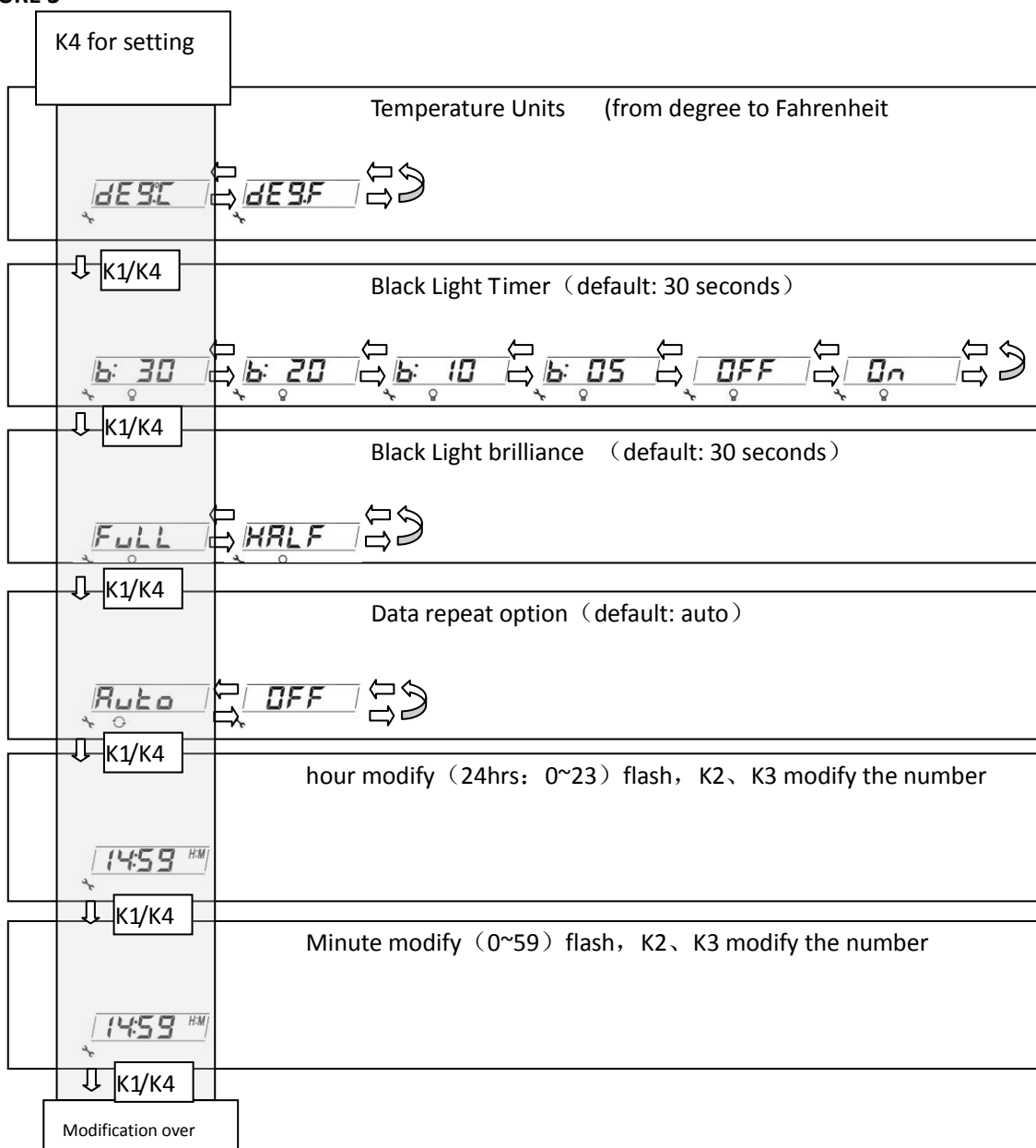

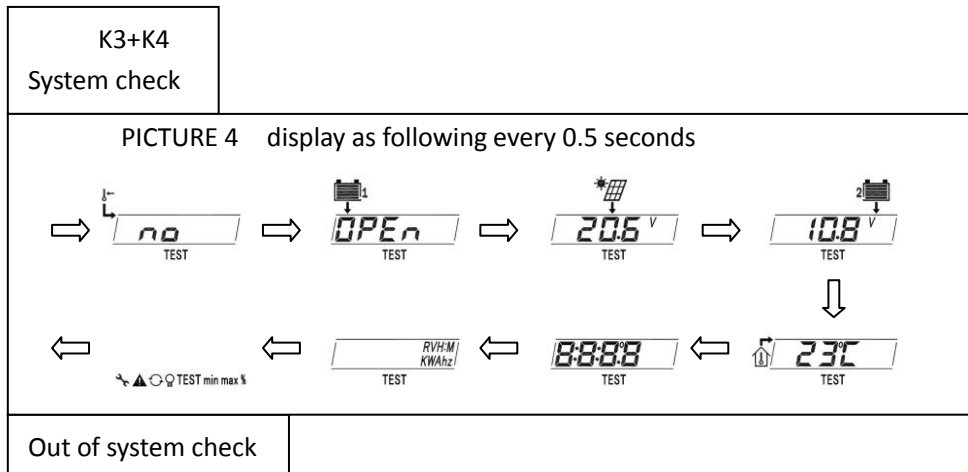

OTHER INSTRUCTION:

Specifications:

Rated voltage: 12V, suggest min voltage: 8.0V.

Low backlight on: <23mA, no backlight and LED.

Strong backlight on: <20mA

Backlight and LED indicator off: <17mA

Working temperature: -15°C ~ +40°C, the LCD will give wrong data while out of the temperature range.

Humidity: 0-100%

Communication cable: RJ45(8PIN), 10 meter.

Trouble indicator on : following occasion may occur, check the connection. And the symbol will disappear automatically when it resume.

1. While one battery disconnect, or open circuit, or over voltage.
2. The remote temperature sensor is no probe.
3. Over charging current
4. Solar PV short-circuit.

Telecommunication port: while the meter run by individual power or communication cutoff, display temperature, battery, solar panel symbol only, data shows 4 pieces of “_”. Press key, no answer. The display will resume while communications is on.

Note: the data displayed will come from the communication, check if the cable correct if the data is wrong. Too long cable may bring mistakes too. The data will update every 20 seconds.

Battery capacity strip flash: each strip equals to 20% of battery capacity. The over part will be showed as flashing. For example, the first trip flash, the battery capacity is 1-19%, the second trip flash, it is 21-39%, etc. the calculation is based on fully charged voltage, and over discharged as 0%. All is calculated as the battery voltage, not the real capacity of battery.